

V E S T ATM
SPACE REDEFINED

INSTALLATION GUIDE

TABLE OF CONTENTS

Overview & Terminology.....	4
Tools & Equipment.....	6
Cutting Steel	7
Installation Guidelines.....	8
Preparation	9
Inside Corners	11
Outside Corners	14
Starter Strip	15
Windows & Doors	16
Gables.....	20
Panel Fastening Specifications	21
Panel Layout & Installation.....	22
Tips & FAQs.....	27

VESTA PANEL DETAILS



HD3 WOODGRAIN
6 Distinct Woodgrains







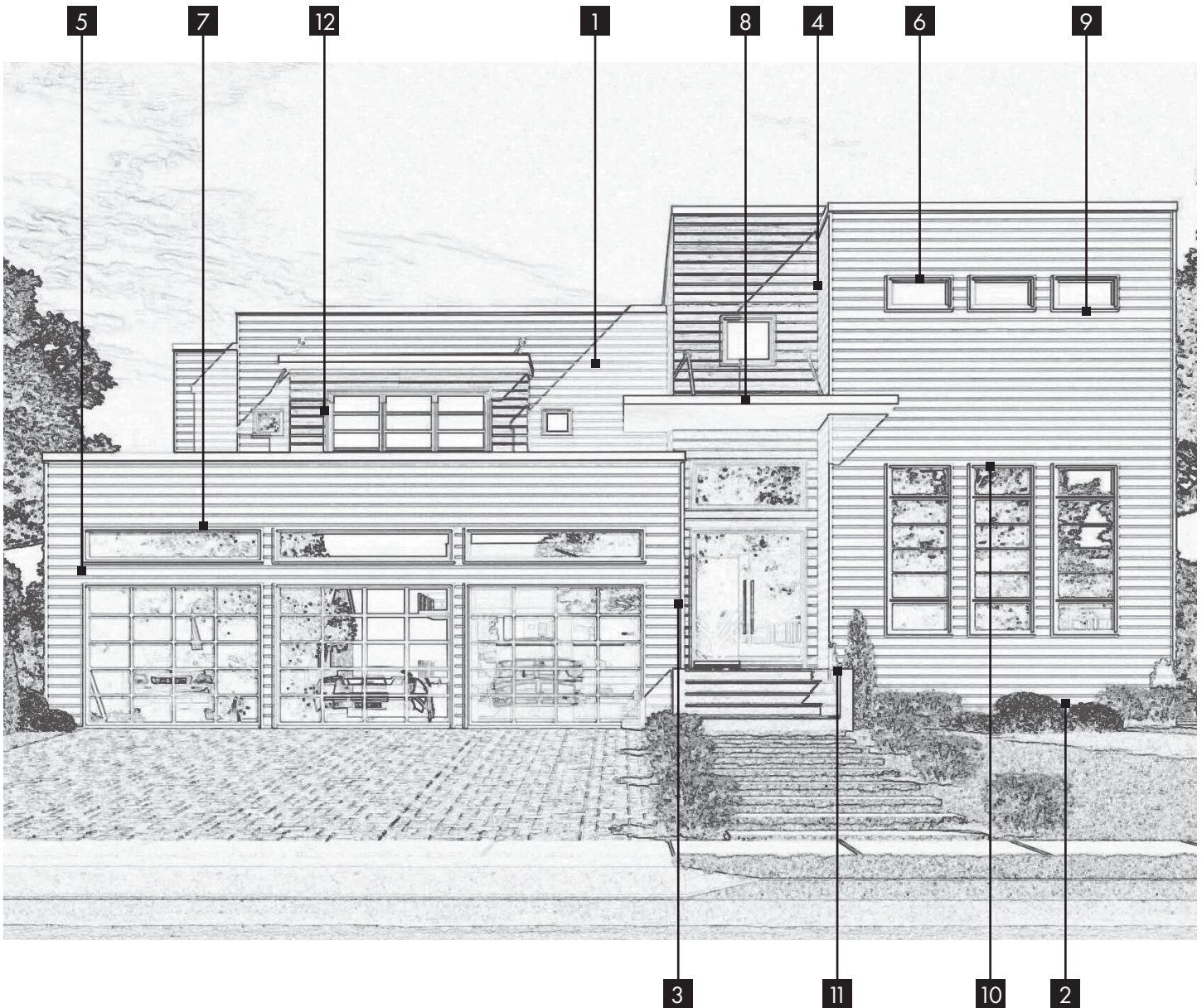







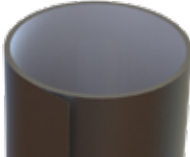

SOLID
Matte Textured Finish

OVERVIEW AND TERMINOLOGY

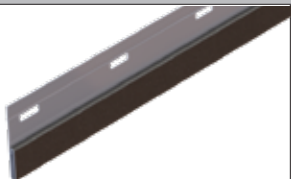

VESTA COMPONENTS AND SYSTEM ACCESSORIES

1	Plank Panel		8ft woodgrain panels and 12ft solid panels
2	Plank Starter Trim		Secures your first row of panels to the wall. This Starter Strip is specially designed to work with the plank panel.
3	Outside Corner Post		Installed at the outside corner of the wall, allowing siding to be inserted on both sides.
4	Inside Corner Block		Used to flash inside corners.
5	H-Channel		Can be used to seam panels.
6	J-Channel		Used to hide cut edges of siding. Also used around sides and tops of windows and doors, eave line of gables, roof line of rakes, and in other areas where panel must be cut or notched.
7	Plank Drip Cap		Installed above windows and doors to keep water away. Drip Cap is color matched.

8	Trim Coil		Use for custom flashing.
9	Support Trim		Install trim behind panels. Supports cut panels and keeps them flat.
10	Utility Trim		Used to cover cut edge of panel.
11	Brick Ledge Flashing		Install above brick or stone to keep water out.
12	L-Flashing		Install as an alternative to J-Channel on the sides of windows or doors.
Touch-Up Paint			
			Use only to touch up the panel.
1 1/2" Nails			
			Steel Roofing nail with electro-galvanized finish, 11 gauge, 1 1/2" length
1 1/2" Screws			
			1 1/2" #10 zinc coated pan head.

TOOLS & EQUIPMENT

Required Tools

- Hammer
- Level (2 ft. and 4 ft.)
- Tape Measure
- Power Saw
- Ferrous Cutting Saw Blade
- Electric Shear
- Utility Knife
- Safety Goggles
- Aviation Snips
- Flathead Screwdriver
- Caulk Gun
- Speed Square
- Needles Nose Pliers
- Cordless Driver
- Tin Snips
- Chalk Line
- Sheet Metal Gloves
- Hand Seamer
- Foam Pad
- Driver bit for Panel Screws (if using screws)

Helpful Tools

- Sheet Metal Brake
- Power Shears
- Ladder Hook
- Table Saw
- Circular Saw
- Trim Coil
- Touch-up Paint
- Nail Punch
- Butyl or urethane based caulk

Ladders and Scaffolds

Many different styles and options are available. Most common system used by siding professionals are extension ladders and ladder jacks, simply because of there portability and minimal cost. Contact your local OSHA office for specifications on proper scaffolding for your particular need.

CUTTING STEEL SIDING

The best saws to use when cutting steel siding are a sliding miter saw and a siding cutting table using a circular saw. Never set up your saw in an area that will throw cutting chips on or at the steel siding. Hot chips can damage the paint and protective coating.

Saw Blade Type

When cutting steel siding a ferrous cutting blade must be used. A carbide tip saw blade with the max number of teeth per the diameter of the blade. Cutting thin steel requires lots of teeth on the saw blade. Never use a grinder or an abrasive type of saw. Failure to do this may damage the protective finish applied to the siding and void the warranty. Always make sure to wear protective safety glasses and gloves when cutting/handling steel siding. Follow safety instructions that accompany your tools/blades and wear the suggested protective gear.



Siding Cutting Table

This table allows for a normal circular saw to be used with the proper steel blade to cut siding and soffit, especially helpful for angled cuts on peaks and rakes. These tables are lightweight and portable and can be set up and moved by one person with ease. These tables also allow for the saw to be away from the siding when being cut. This allows for fewer scratches or damage to occur to the siding panels.



Sliding Miter Saw

When cutting steel siding one option is to use a sliding miter saw. Never plunge down into the steel panel, start off the steel panel then push down and thru the panel slow.



Electric Shear

This tool may be used for length wise cuts across face of siding. Especially helpful for window and door cuts.



Tin Snips

Tin snips may be used to cut siding. Also used to cut J-Channel, finish trim, and O.C.P. Offset snips are the best. Use Left-hand and right-hand snips for detailed cuts.



INSTALLATION GUIDELINES

General

Plank must be installed on a minimum 1/2" O.S.B. or plywood solid flat wall over house wrap such as Tyvek® Brand from DuPont™.

Fastening

Fasten all panels loose (floating) to the wall using only the required nail or screw type, inserting fastener into the holes along the top of the panel 16" on center. Ensure each panel is fully engaged to the one below via the pre-rolled feature at the bottom of the panel before fastening it.

For details on fastening, see pg. 21.

Storage

Metal building materials should always be stored in a dry, well-ventilated place. Never cover materials with a non-breathing or plastic tarp. This causes condensation to form, which deteriorates the protective coating of the material.

Handling

Carry the plank panels standing on their edge, instead of laying flat, to keep them from bending and warping.

Galvanic Corrosion



Also known as bimetallic corrosion, may occur when two dissimilar metals are in contact with

one another in the presence of an electrolyte creating an electronic pathway for the movement of electrons (such as water). The potential difference between the metals is the driving force behind the corrosive reaction.

Steel siding and trim must never come in contact with other metals like aluminum. Flashing tape can be used as a spacer to separate the metals.

Safety Guidelines

Follow all governmental safety procedures, including, but not limited to, all OSHA guidelines. Always wear safety gloves, safety glasses and fall protection gear when installing plank panels.

Maintenance

Remove any and all debris that may accumulate on the wall during its lifespan to keep it moisture free. Tighten any loose fasteners or trim pieces as access allows. Do not attempt to repair or replace any parts of the system without consulting a certified applicator. Repainting the wall should not be necessary through the duration of the warranty.

Warranty

Register the warranty by filling out the form on QualityEdge.com/warranties. This is required to begin any coverage.

PREPARATION

Surface Preparation

Remove and replace any rotted or damaged boards. Check for waves in the wall and shim out (or build out) if necessary. Nail or screw down any loose boards or trim. Scrape away any old caulking, especially where it may interfere with the new trim pieces (windows and doors). New caulking should be installed to seal any air leaks where old caulk was removed. Remove or loosen objects that may be in the way of the new panels (downspouts, cables, planters, shutters, house numbers, mailboxes etc.). If meter boxes or power lines must be removed contact a local professional.



Figure 9.1

House Wrap

For the typical siding application house wrap must be placed on the exterior of the wall. **[Figure 9.1]** Home wrap (such as Tyvek® Brand from DuPont™) will prevent drafts from occurring, and will also shed any moisture that may get behind the siding. Follow brand install details for house wrap. **[Figure 9.2]**



Figure 9.2

Window and Door Build Out

This is an optional step but adds a great deal to the overall appearance of the finished job. When insulating or applying fan fold, build out the window and door casing using a trim board of choice. This is done so you have something to butt your J-Channel to, and also hides the back side of the J-Channel.

NOTE: Steel siding and trim must never come in contact with other metals like aluminum. Flashing tape can be used as a spacer to separate the metals.

PREPARATION

Straightline

A chalk line is a good way to start an installation. Often times this is used to develop a reference line as to which the starter strip can be installed. We recommend measuring equal distances down from the eave line, or from the window sills that are at the same height.

[Figure 10.1] This line allows for the siding to be run parallel with the eaves or windows which gives the appearance that the siding is running level regardless of the actual levelness of the house or ground.

Level

Start an installation by check to see if the walls are level. If the walls are reasonably level a chalk line and level may be used to determine a line for the starter strip to be installed. This is done by driving a nail at the desired height for the top of the starter strip. Connect the end of the chalk line to the nail and pull to the opposite end of the wall, make sure to pull the line tight. Then use a level in the middle of the line to determine where the chalk line should be snapped. Be sure there is no sag in the line when it is snapped, this can easily occur when the line is stretched over 20'. Continue this process on all sides of the building making sure the line matches up on all sides. This is very important because this is the basis for all subsequent rows of siding.

NOTE: It is recommended to use a level 4 ft. or longer in this process and also to take level readings at the center of the line.

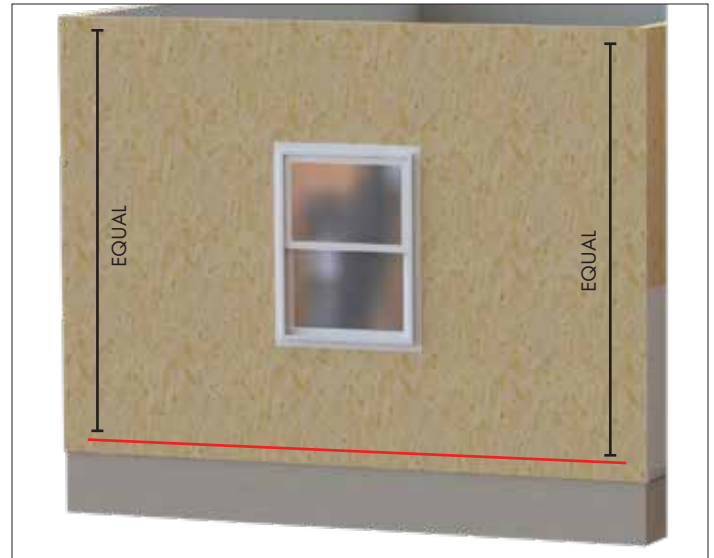

Figure 10.1

INSIDE CORNERS

Option 1: J-Channels

Two J-Channels at right angles may be used for the inside corners. **[Figure 11.1]** Install a small bead of caulking where the two J-Channels meet one another.

[Figure 11.2] J-Channels should be installed at full lengths, 1/2" below the bottom of the starter strip and extending to the eave line or gable trim. If a shorter piece is needed to reach the eave or gable trim be sure to overlap the bottom piece with the top piece. J-Channel flanges should be nailed every 12", making sure not to drive the nails to tight. Driving nails to tight may cause a distortion to occur in the J-Channel. J-Channels can easily be cut with a pair of aviation snips.

Siding is installed into the receiving end of the J-Channel, making sure to leave 1/16" of space between the back side of the J-Channel and siding. **[Figure 13.3]**

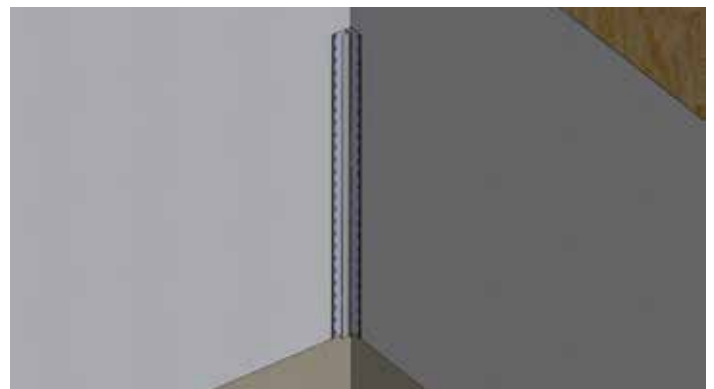

Figure 11.1

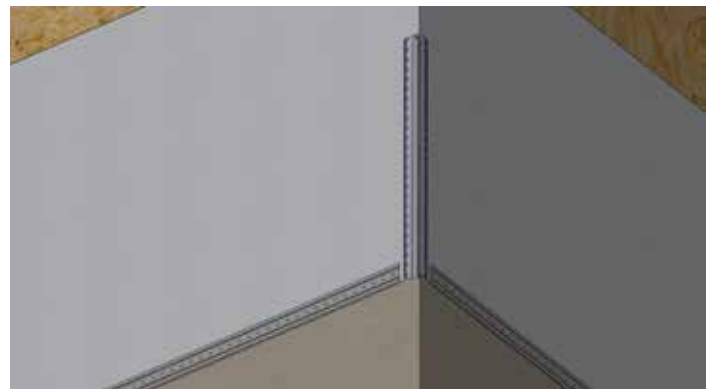

Figure 11.2

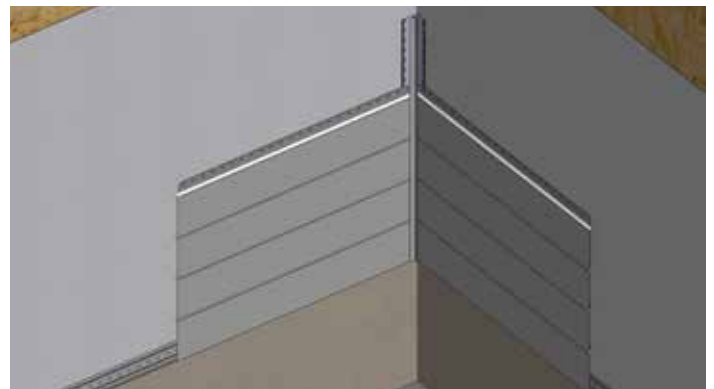

Figure 11.3

INSIDE CORNERS

Option 2: Inside Corner Block with 2 Finish Trim J-Channels

Option 2 Inside corner block with 2 Finish trim j channels

Mount the corner block onto the wall starting at the bottom of the wall. **[Figure 12.1]** Overlap the net piece ovetop of the lower block.

Install the J-Channels on the two sides of the inside corner block. **[Figure 12.2]**

Fit panels into the J and keep a $\frac{1}{8}$ " gap in between the inside of the J and the panels. **[Figure 12.3]**



Figure 12.1

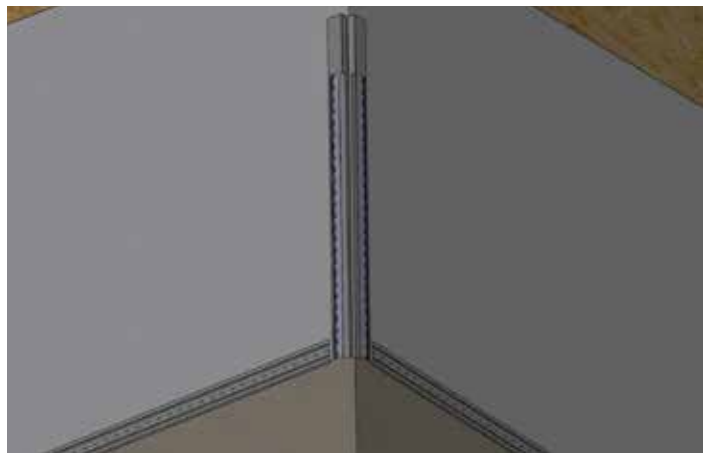

Figure 12.2

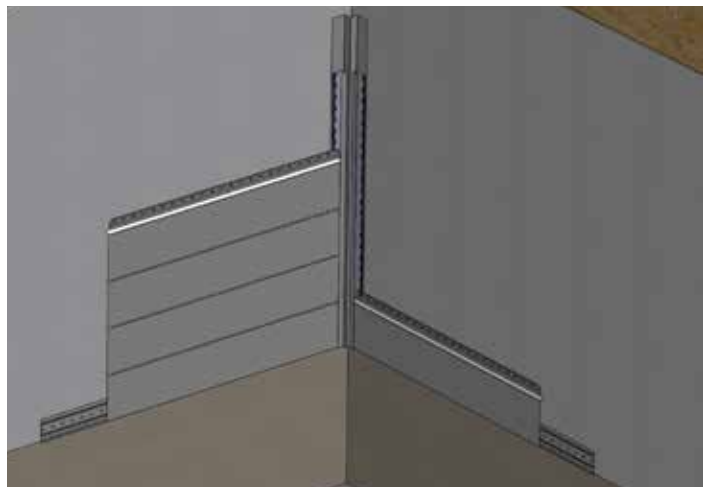

Figure 12.3

INSIDE CORNERS

Option 3: Inside Corner Block

Mount the corner block onto the wall starting at the bottom of the wall. **[Figure 13.1]** Overlap the net piece overtop of the lower block. **[Figure 13.2]**

Fit panels up to the inside corner block. **[Figure 13.3]** Anchor the panel of siding on the side of the corner block by nailing in between the nail holes. Use all the nail holes for the rest of the panel for expansion and contraction. This will keep the panel from walking away from the corner block.

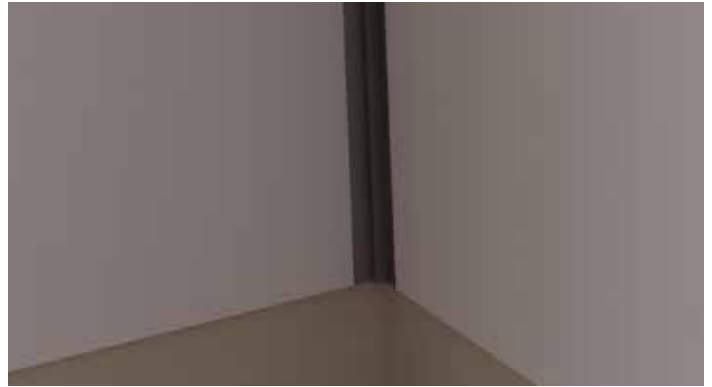

Figure 13.1

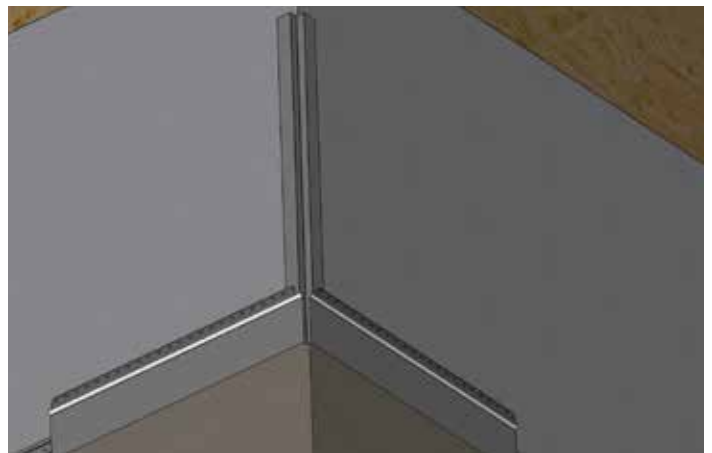

Figure 13.2

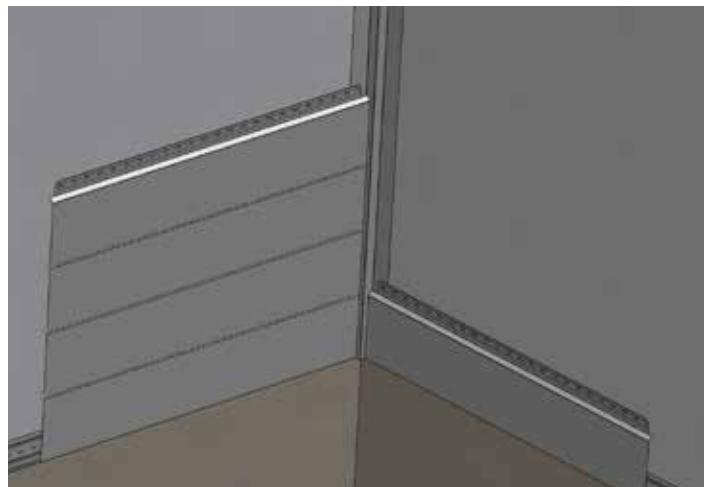

Figure 13.3

OUTSIDE CORNERS

Small Outside Corner Post (O.C.P.)

The bottom of the O.C.P. can be capped by cutting away the J-portion of corner and folding the remaining faces of corner back to close the bottom of corner. **[Figure 14.1 & 14.2]** Tops of corners may be capped in the same fashion.

Corner posts should be installed prior to the siding panels.

Small O.C.P. Installation

The O.C.P. is installed in the same manner as the inside corners, 1/2" below the bottom of the starter strip and running to the eave line or gable trim. If more than one post is needed to reach the desired height be sure to overlap bottom corner with the top corner. Be sure to install nails every 12" on both nail flanges. Avoid driving nails to tight because distortion can occur if this is done. Make sure corners are installed squarely to the wall, this will add to the final appearance of the job.

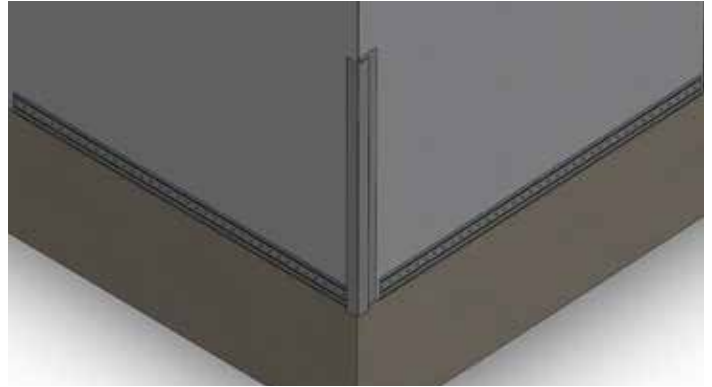

Figure 14.1

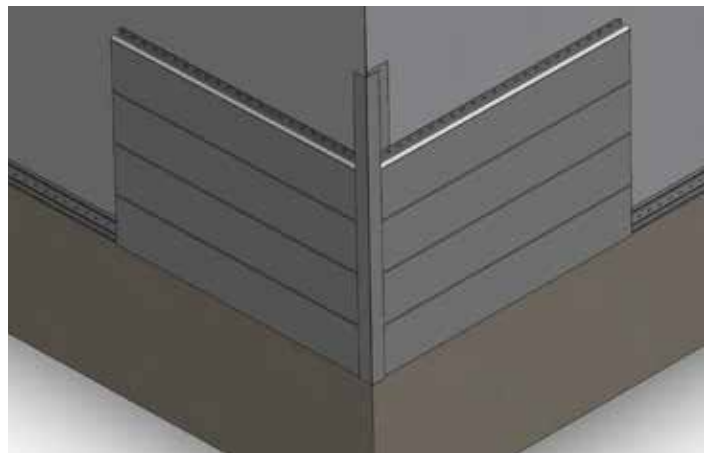

Figure 14.2

STARTER STRIP

Plank Starter Strip

Using your chalk line previously established, install top of starter strip on the line. **[Figure 15.1-17.3]** Be sure to build out any hollow spots behind starter strip to prevent any wavy appearances in bottom row of siding. Make sure starter strip is straight and meets accurately at all corners of building.

Nailing/Driving Screws

Be sure to install starter with nails/screws spaced no more than 12" O.C. Be sure to nail/screw starter strip as low as possible this will provide extra rigidity to bottom row of siding. Do not overdrive nails or screws to prevent distortion. Butt starter strip to each other. Starter can be cut with tin snips when shorter lengths are needed.

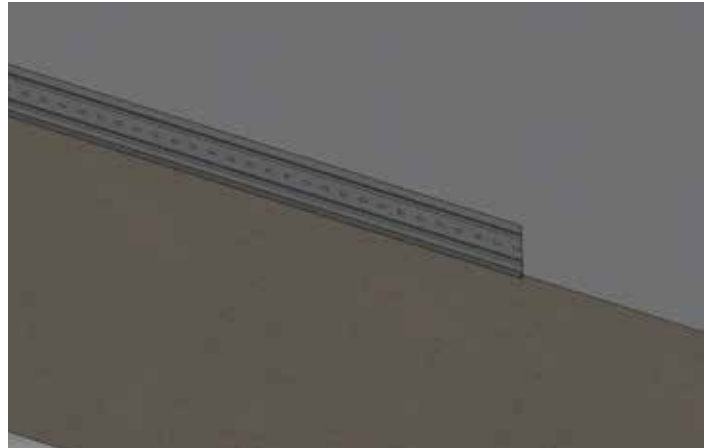

Figure 15.1

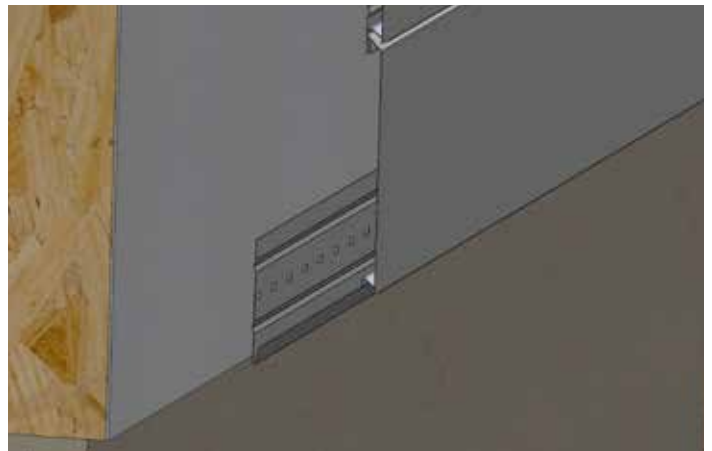

Figure 15.2

Other Starter Methods

Starter strip may not work in all situations, often times J-Channel may be used to start rows of siding especially over decks, concrete porches, brick, retaining walls, garage doors etc.

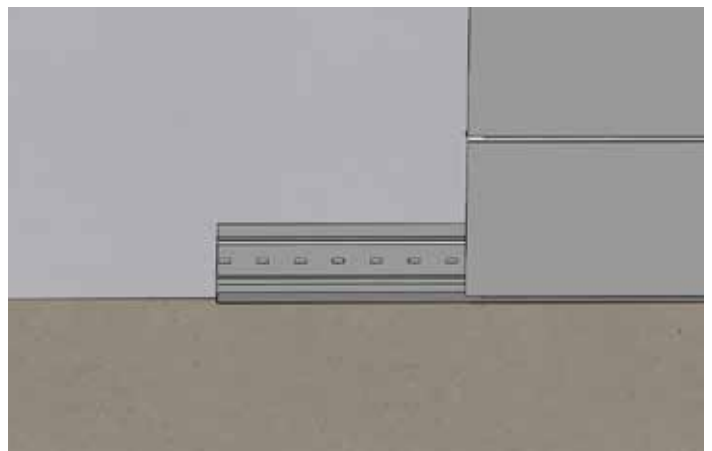

Figure 15.3

WINDOWS AND DOORS

Drip Cap

Plank has a color matched drip cap that can be used as an alternative to standard steel drip cap. This drip cap has angles to help cover different size windows and doors. **[Figure 16.1]** Install the drip cap over the window or door **[Figure 16.2]**, then mount the J-Channel. **[Figure 16.3]**

Panels at Windows and Doors (Tops)

Cutting out the tops of windows and doors is nearly the same as the bottoms. The difference in this process is the clearance needed to install the siding. When measuring your clearance, measure tight to the inside of the J-Channel. When cutting horizontally, cut an extra $\frac{1}{4}$ " to allow for the bottom of this panel to slide over the lock of the lower panel and engage it.

Support Trim

Check to see if you need any support trim to keep the panel supported. If needed, nail support trim behind the finish trim that covers your horizontal cut.

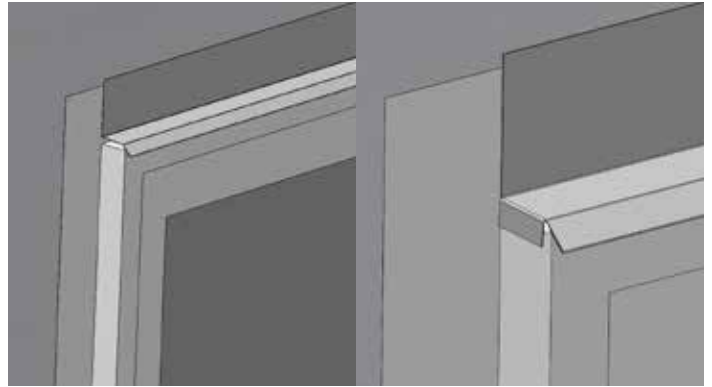

Figure 16.1

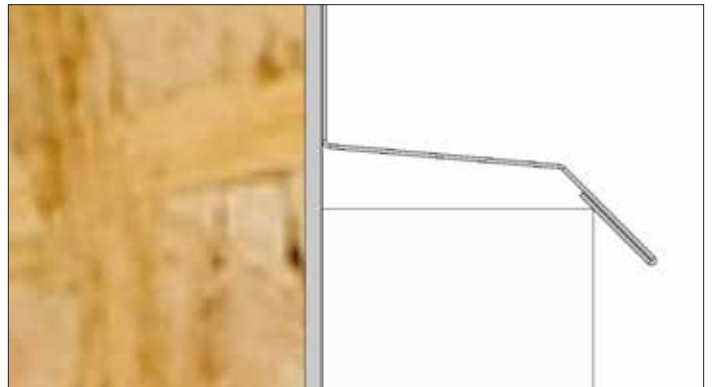

Figure 16.2

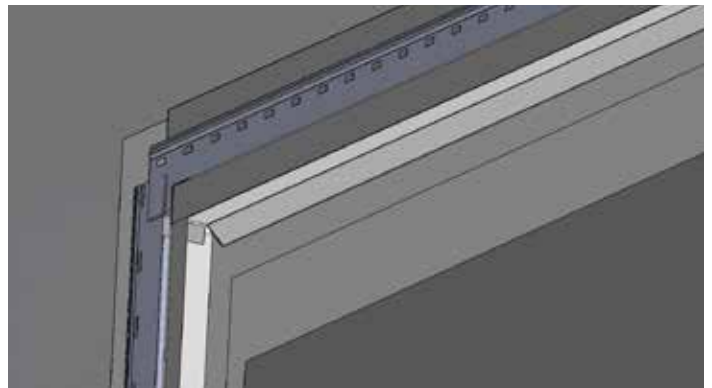

Figure 16.3

WINDOWS AND DOORS

J-Channel

Finish trim can be installed around windows and doors.

[Figure 17.1] This is done so the butt end of the siding can be slipped into the 1/2" opening. The side pieces of finish trim are left 1/2" above the window top, and 1/2" below the window sill. The bottom of the finish trim has a v-groove notched out of the back side and nail flanges (1/2" depth). This allows for the siding to slip into the finish trim and hide the cut of the finish trim. The top of the finish trim has the back side notched out 1/2", leaving the face and nail flange in place. The top finish trim is cut to fit from outside to outside of the side finish trim. A 1/2" slit is cut into the corners of the finish trim and top is folded down inside the side finish trim pocket. Be sure to put the face of top trim over the face of the side trim. Drip cap needs to be installed before the finish trim at the top of the windows and doors.

Flashing

It is a good idea to install window tape over existing window nail flange. Also you may install a piece of window tape or coil stock under the nail flange of the side finish trim and lap over the nail flange of the siding panel directly under the window or opening. This will allow water to run over the top of the siding and out the weep holes in the bottom of the siding instead of behind the siding panel.

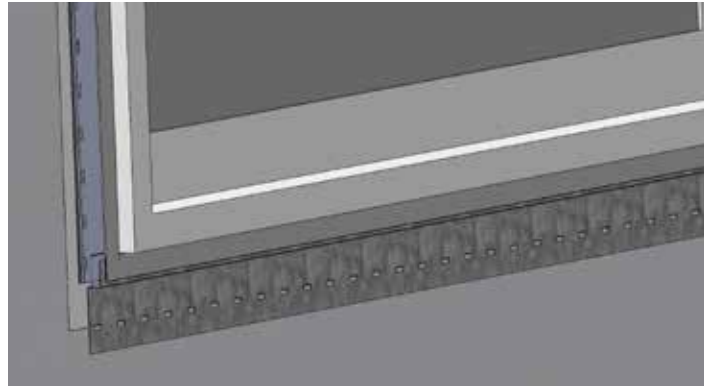

Figure 17.1

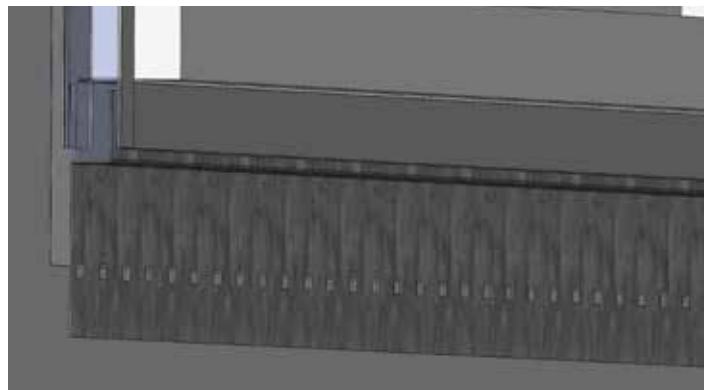

Figure 17.2

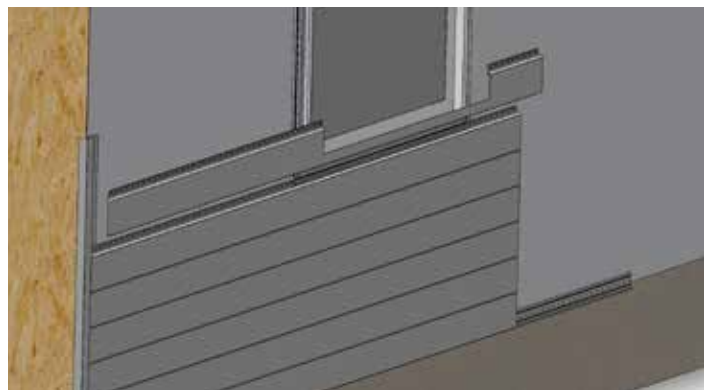

Figure 17.3



Figure 17.4

WINDOWS AND DOORS

L-Flashing

L-Flashing can be used as an alternative to J-Channel on the sides of windows and doors. **[Figure 18.1]**

Fit panels up to the L-Flashing. Anchor the panel of siding on the side of the L-Flashing by nailing in between the nail holes. Use all the nail holes for the rest of the panel for expansion and contraction. This will keep the panel from walking away from the L-Flashing. **[Figure 18.2]**

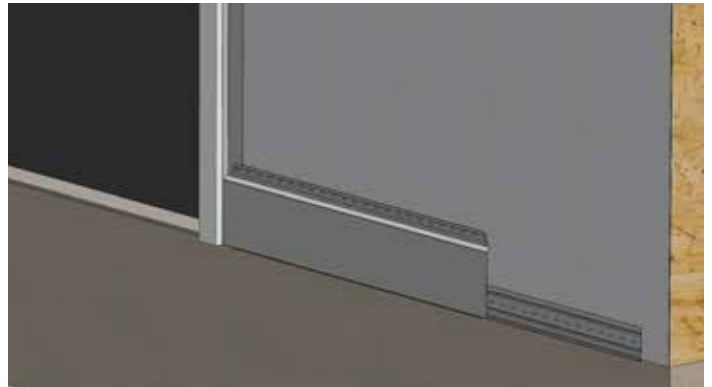

Figure 18.3

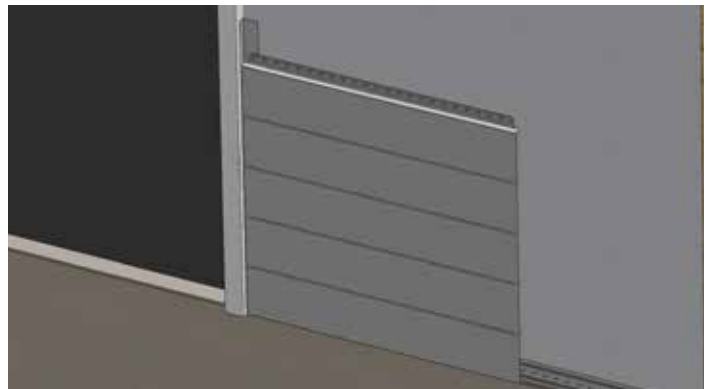

Figure 18.3

WINDOWS AND DOORS

Brick Ledge Flashing

Brick ledge flashing is used to keep water from getting behind stone or brick. Install this flashing before the finish trim J. **[Figure 19.1]**

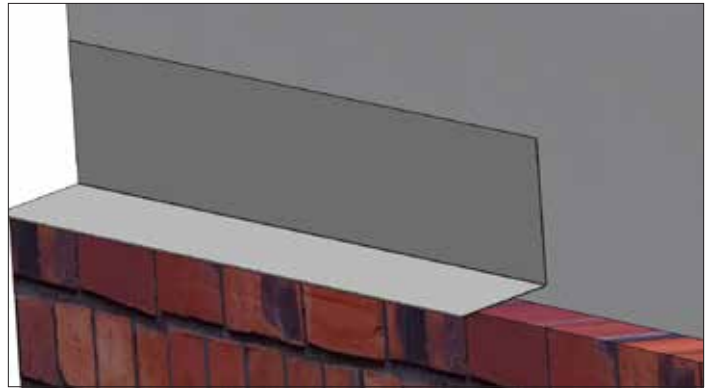

Figure 19.1

GABLES

Gable Sidewall Finish Trim

Prior to siding installation a finish trim may be placed at the bottom of the sidewall. This allows cut ends of siding to be hidden. Start finish trim at bottom of gable sidewall and work to the top of the gable. Be sure to overlap bottom finish trim with top finish trim if more than one piece is needed to reach top. At the top of the gable butt one finish trim into the peak and overlap this finish trim with the other side finish trim. Nail or screw every 16".

Installing Panels in the Gables

When installing in gables, it works better to use short pieces and not full length panel if possible. Support trim will be needed for the last panel.

PANEL FASTENING SPECIFICATIONS

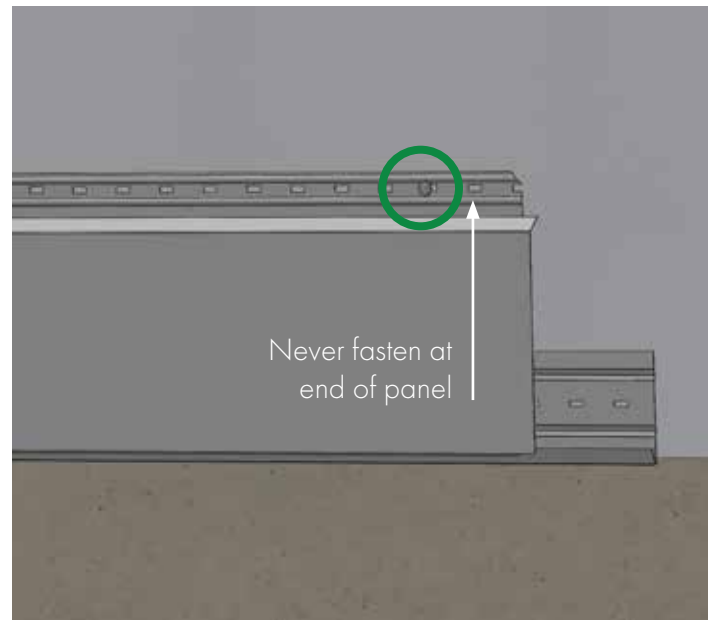
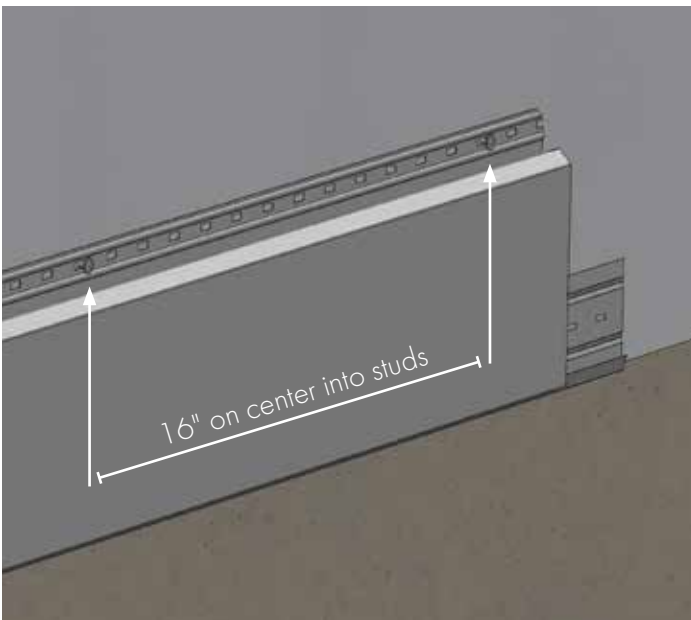
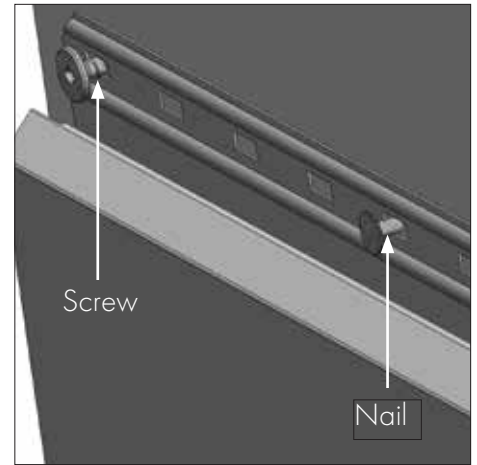
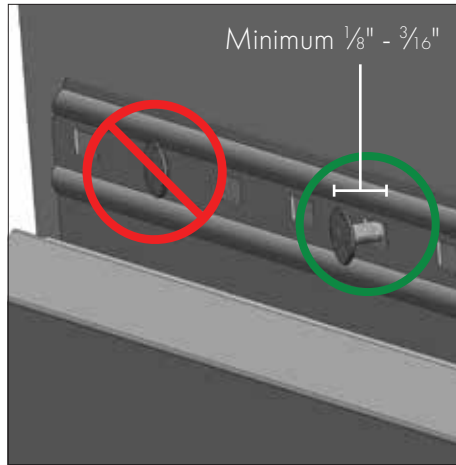
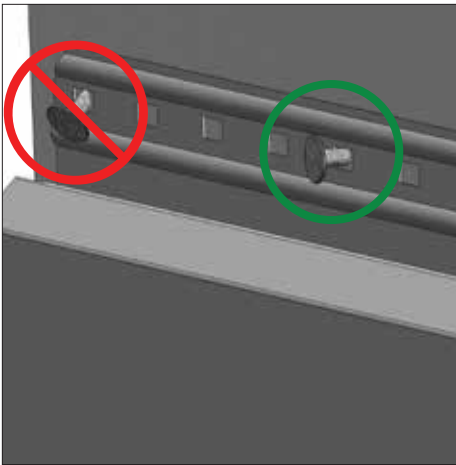

Fasten all panels loose (floating) to the wall using only the required nail or screw type, inserting fastener into the holes along the top of the panel 16" on center. Ensure each panel is fully engaged to the one below via the pre-rolled feature at the bottom of the panel before fastening it.

IMPORTANT:
To avoid oil canning, do not tightly fasten the panel to the wall. The panel should look like it's hanging on the screw or nail. Do not push down with intense force while fastening the panel.

PANEL LAYOUT AND INSTALLATION

Siding Overlap Options

Option 1: Slide the 1/2" tab inside the panel but leave a 1/8" gap by the nailing flange. This option will give you the largest overlap and will close the bottom notch in the siding the most. Always use this option when installing panel on the wall. **[Figure 22.1]**

Option 2: Only use option 2 when installing around windows, doors or any obstacles on the wall.

Overlap the panel 1/2" and do not slide the panel into the next panel. **[Figure 22.2-3]** When installing around windows, doors and any obstacles on the wall it can be hard to interlock the panel. Only use this option when needed because it will leave a larger gap on the notch in the lower end of the siding panel.

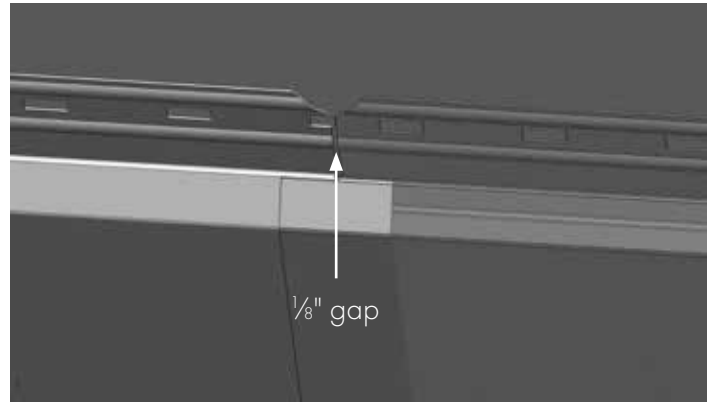

Figure 22.1

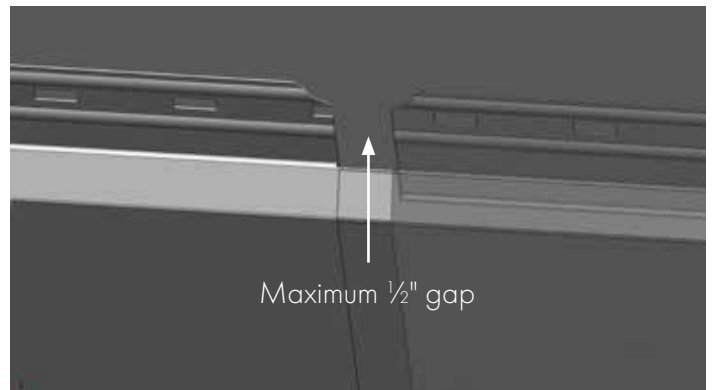

Figure 22.2

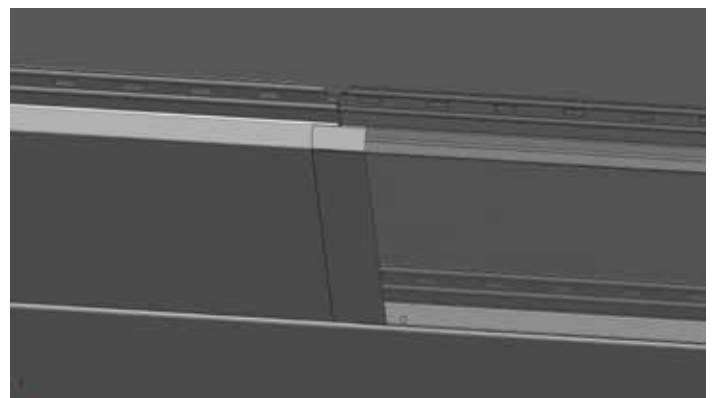

Figure 22.3

PANEL LAYOUT AND INSTALLATION

Row One

Row one is the most important row of siding on the building. This row is the basis for all other rows of siding to be installed. Make sure this row runs parallel to the eaves and or windows, or is level depending on the situation. **[Figure 23.1]** Install bottom lock of siding around bottom edge of starter strip, be sure that entire bottom lock of siding is around the bottom of starter. Be sure not to pull to hard on this row when nailing, if forced to hard a distortion of the panel may occur. Check for alignment of inside and outside corners making sure panel matches up at all corners. You should have a minimum of 6" clearance between ground and bottom of the first row. Install end of siding into corner post openings first. Apply light pressure down the entire piece of siding, making sure the panel goes into the steel starter strip. Screws should be in the middle of the factory holes provided at the top of the panel.

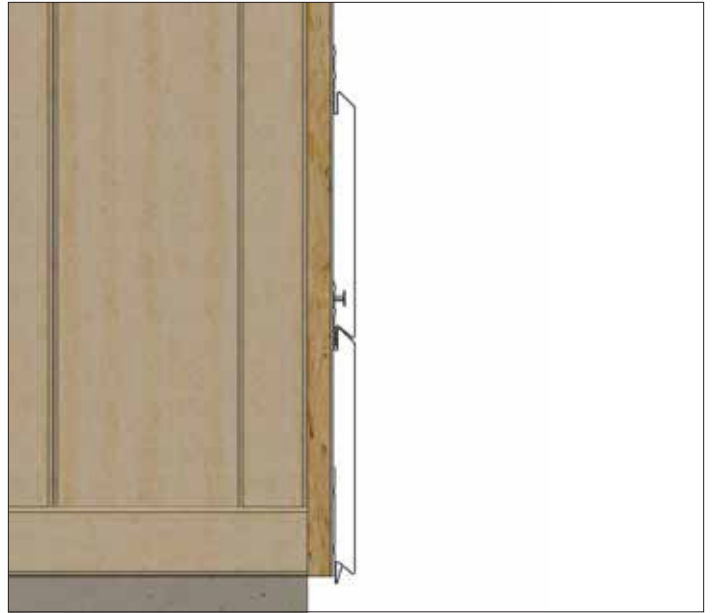

Figure 23.1

PANEL LAYOUT AND INSTALLATION

Panel Install details for Wood Painted Panels

The wood printed panels have 6 distinct wood grains. Printed on the top nailing flange are numbers 1 to 6, these numbers identify the different paints. When installing the panels look at the number and mix them on the wall. The panels are mixed in the box 1 thru 6 from the factory, for the best look install different numbers by the previous panels.

Take care not to install in a stair step pattern with 6 rows high, the cartons are packed 1 thru 6. It is possible to install the panels next to the same number in this step pattern.

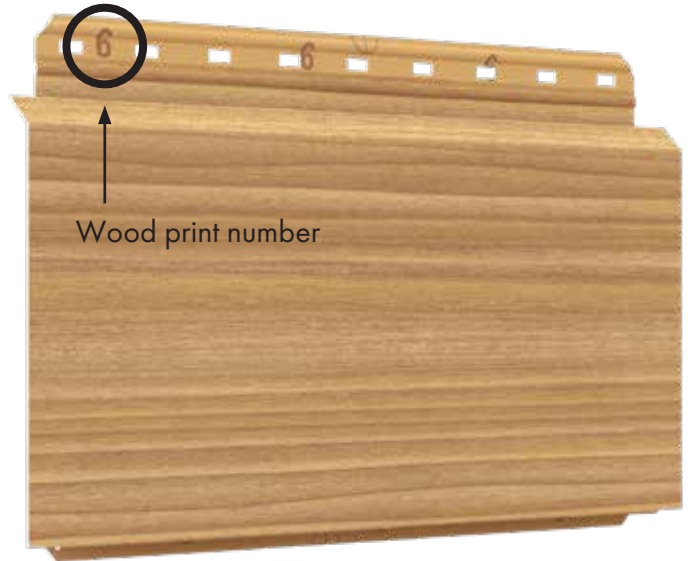

PANEL LAYOUT AND INSTALLATION

Last row of Panel Installation

1. Install the finish trim J under the soffit at the eave edge.
2. Set the support trim inside of the J, this will support the panel
3. Measure the and cut the last panel
4. Push the panel up in between the finish trim J and the support trim
5. Pull the cut panel back down into the lower panel receiver

PANEL LAYOUT AND INSTALLATION

Vertical Installation Option

The plank panels can be installed vertically. **[Figure 26.1]** Use the plank drip cap as a starter to cap the bottom of the panels. Start with a full panel of plank, make sure the panel is parallel to the next wall or corner post. Check this after installing a few panels to keep the wall parallel. Always overlap the upper panel over the lower panel for water management. Installing the panels with a off set pattern can be a fantastic look. If installing with 12 ft. panels a 12ft. then 6 ft. pattern looks great.



Figure 26.1

TIPS AND FAQs

Clean Up

Use a mild soap and water for clean-up with a soft cloth or sponge. Do not rub excessively, this could cause damage to the surface. Do not use harsh abrasives. Mineral spirits may be used sparingly to remove grease or asphalt stains

Job Site

Re-install all fixtures and wires that were removed prior to installation. Scrap pieces, siding boxes, nails debris, etc., should be removed daily.

Additional Tips

It may be necessary to leave J-Channels or corner posts loose around openings to help for installation of short siding panels. You may also have to leave J-Channels off to get short pieces in and slip a J-Channel in after installation. Nailing for this procedure can be done into the back side of the J-Channel at every other row into the casing which it is butted into. A nail set will help in this procedure to set your nails into the wood. If leaving J-Channels loose bow out ends and slip siding into J-Channels and lock together.

FREQUENTLY ASKED QUESTIONS

Q: What do you nail them too? O.S.B.?

A: Minimum of 7/16" O.S.B. and it is best to nail into the studs on horizontal siding.

Q: What to put under the siding?

A: Use the best house wrap you can afford for the project.

Q: What starter to use?

A: Plank siding uses a J-style hook that is color matched because it can be seen after installation.

Q: Can they use nails or screws for siding

A: Screws and nails can be used to install Vesta. A minimum of 1 1/2" long galvanized/zinc roofing nails. #8 galvanized/zinc modified truss screws or lath screws. When mounting into wood use a screw with a sharp point, if mounting onto a steel stud use a self-drilling screw.

Q: Do you have to caulk the gaps?

A: Caulk is not recommended on any gaps on Vesta.

Q: Lots of questions about the accessories, like what J-Channel to use?

A: 1/2" J-Channel (finish trim) is used.

Q: What is L-channel used for?

A: L-Flashing is used as a replacement for J-Channel around windows, doors and more.

Q: How do I replace a bad section of siding?

A: A panel of siding can be replaced by cutting out the bad panel about 1 1/2" down from the upper panel. Cut the full length of the bad panel. Cut the replacement panel as close as possible to the upper lock. Apply construction adhesive to the 1 1/2" steel siding left on the wall. Slide the cut panel under the upper siding and over the 1 1/2" cut panel on the wall and lock it into place.

Q: Steel Siding on a barn or commercial building?

A: Vesta can be use on most buildings if it has
1) wood O.S.B. type of wall
2) Studs to drive the nails or screws, wood or steel

Q: What insulation does QE recommend?

A: QE does not get into the details of a home's construction.

Q: What do I do when I have the siding meeting the aluminum soffit?

A: The paint on the J-Channel will help separate the metals but it is a good practice to leave a small gap between the parts for air flow.

V E S T A™

S P A C E R E D E F I N E D

888.784.0878

QualityEdge.com/Vesta



US Patent No.: 10,508,455



Quality Edge Headquarters

2712 Walkent Drive NW
Walker, MI 49544

Quality Edge Georgia

5520 Export Boulevard
Garden City, GA 31408

Quality Edge Texas

634 107th Street
Arlington, TX 76011

VESTA INSTALLATION GUIDE
Rev. 01/20